

29-09-001 , Engine Control 2,5 I TCI Diesel (Automatic Transmission)

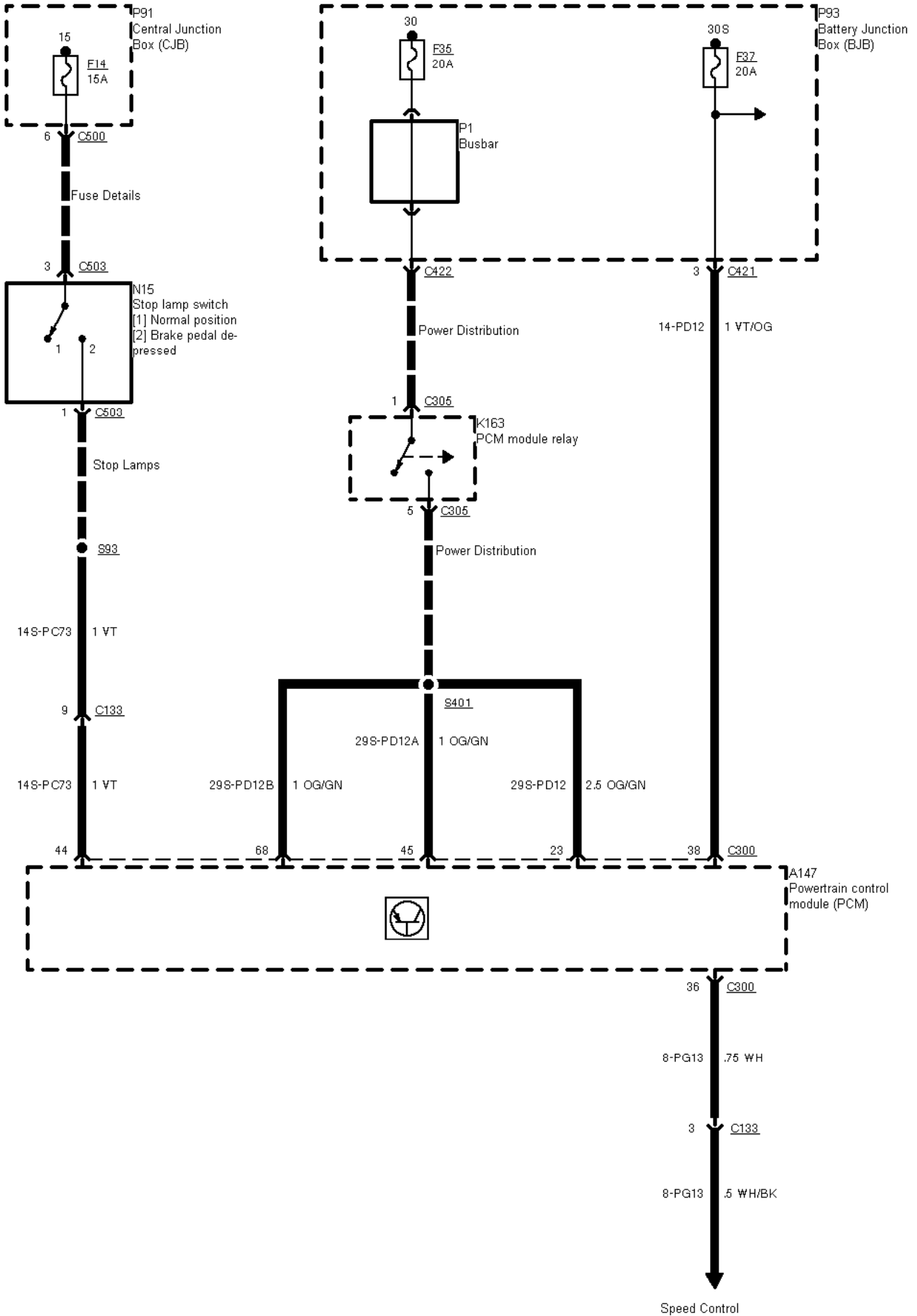

29-09-002 , Engine Control 2,5 I TCI Diesel (Automatic Transmission) , Sensors



module (PCM)

29-09-003 , Engine Control 2,5 I TCI Diesel (Automatic Transmission)

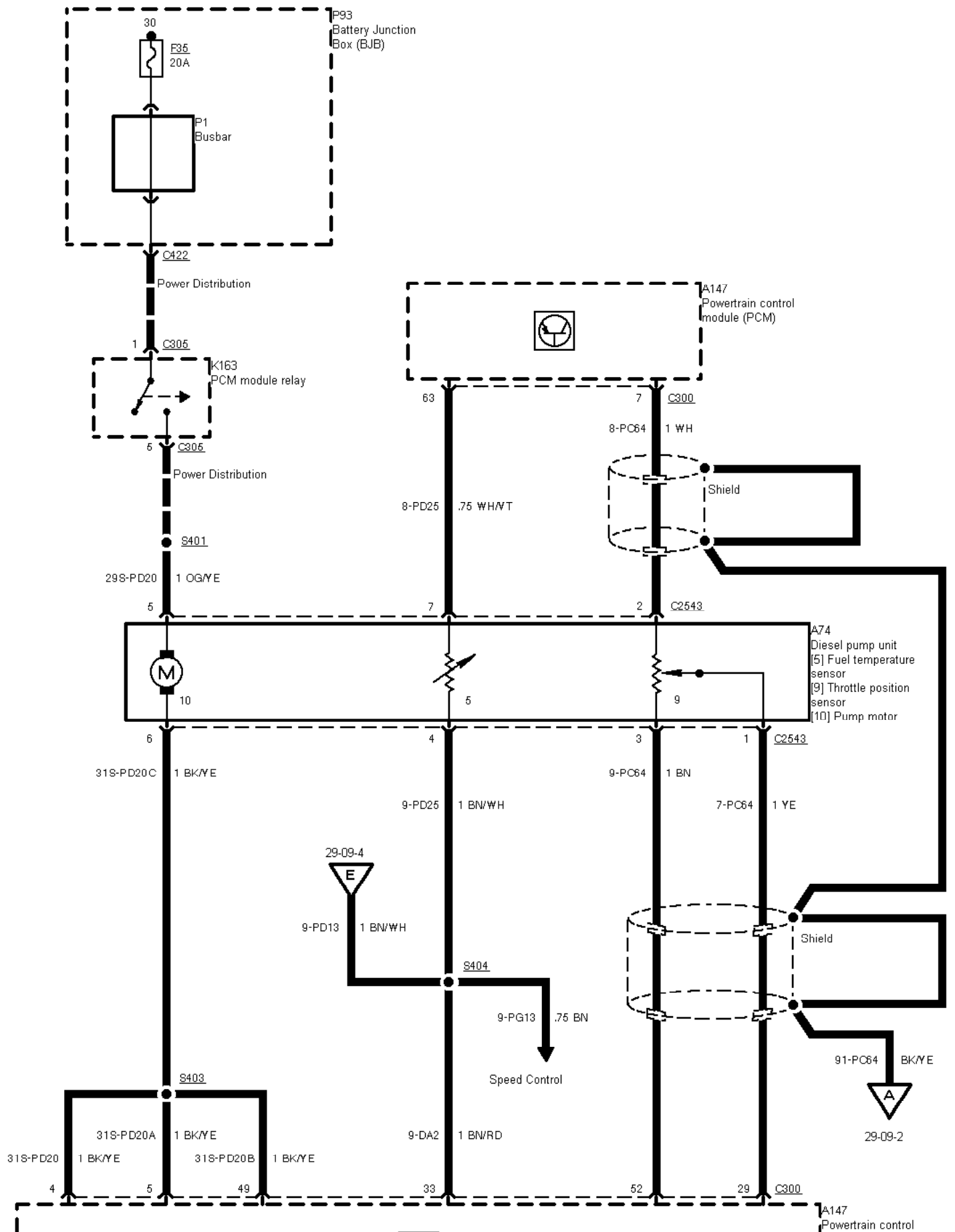



module (PCM)

29-09-004 , Engine Control 2,5 I TCI Diesel (Automatic Transmission) , Sensors

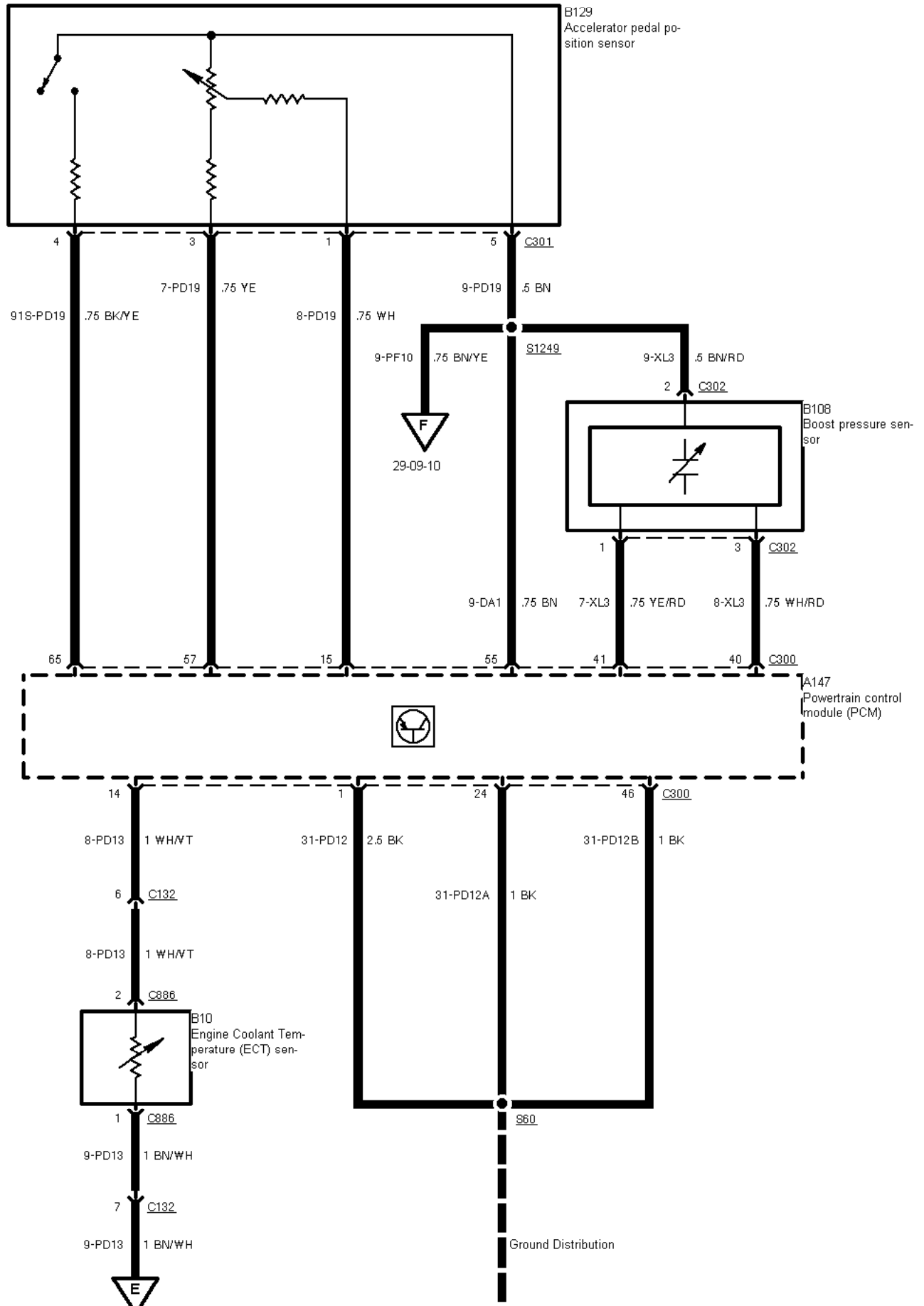

29-09-005 , Engine Control 2,5 I TCI Diesel (Automatic Transmission)

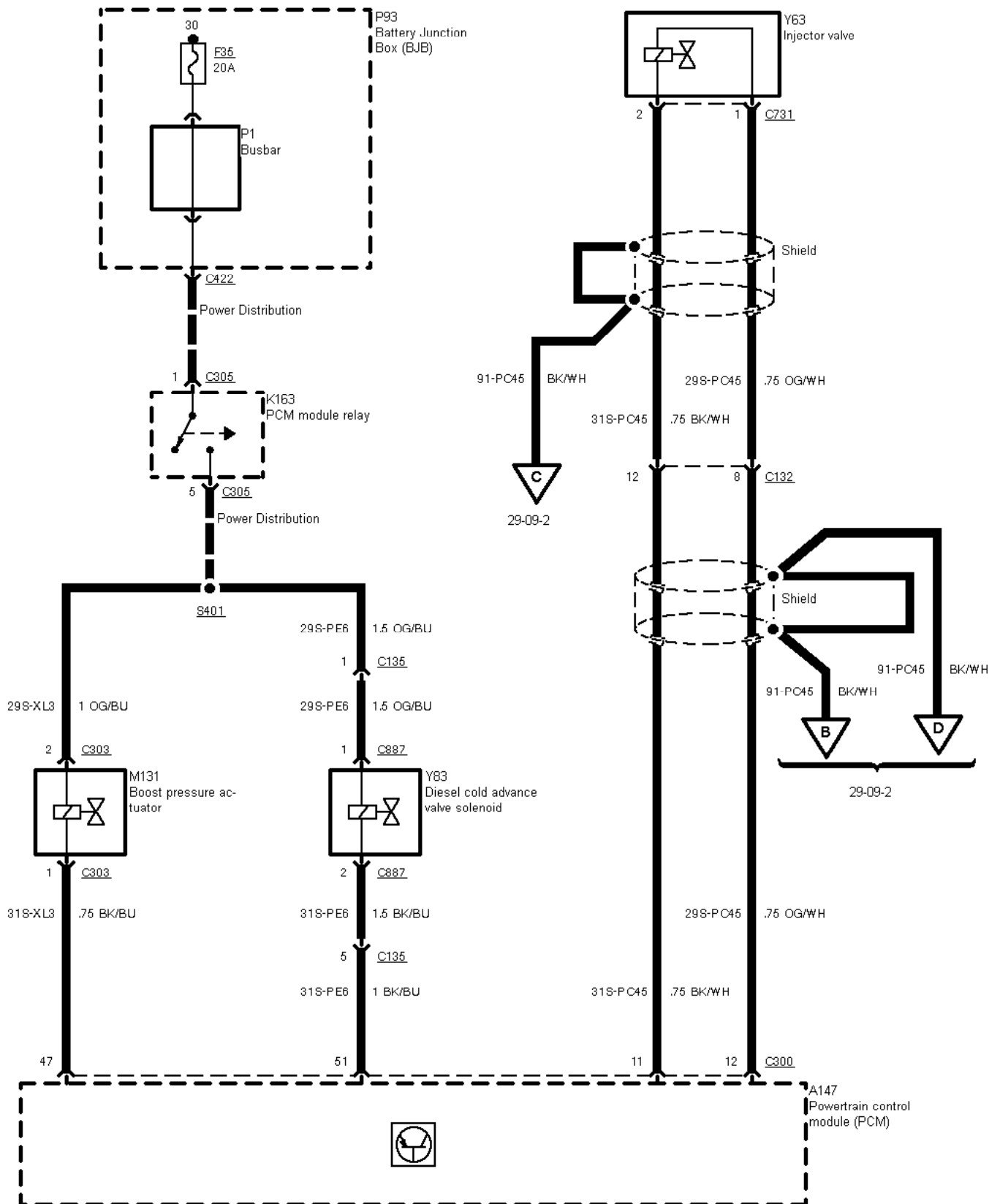

29-09-006 , Engine Control 2,5 I TCI Diesel (Automatic Transmission)

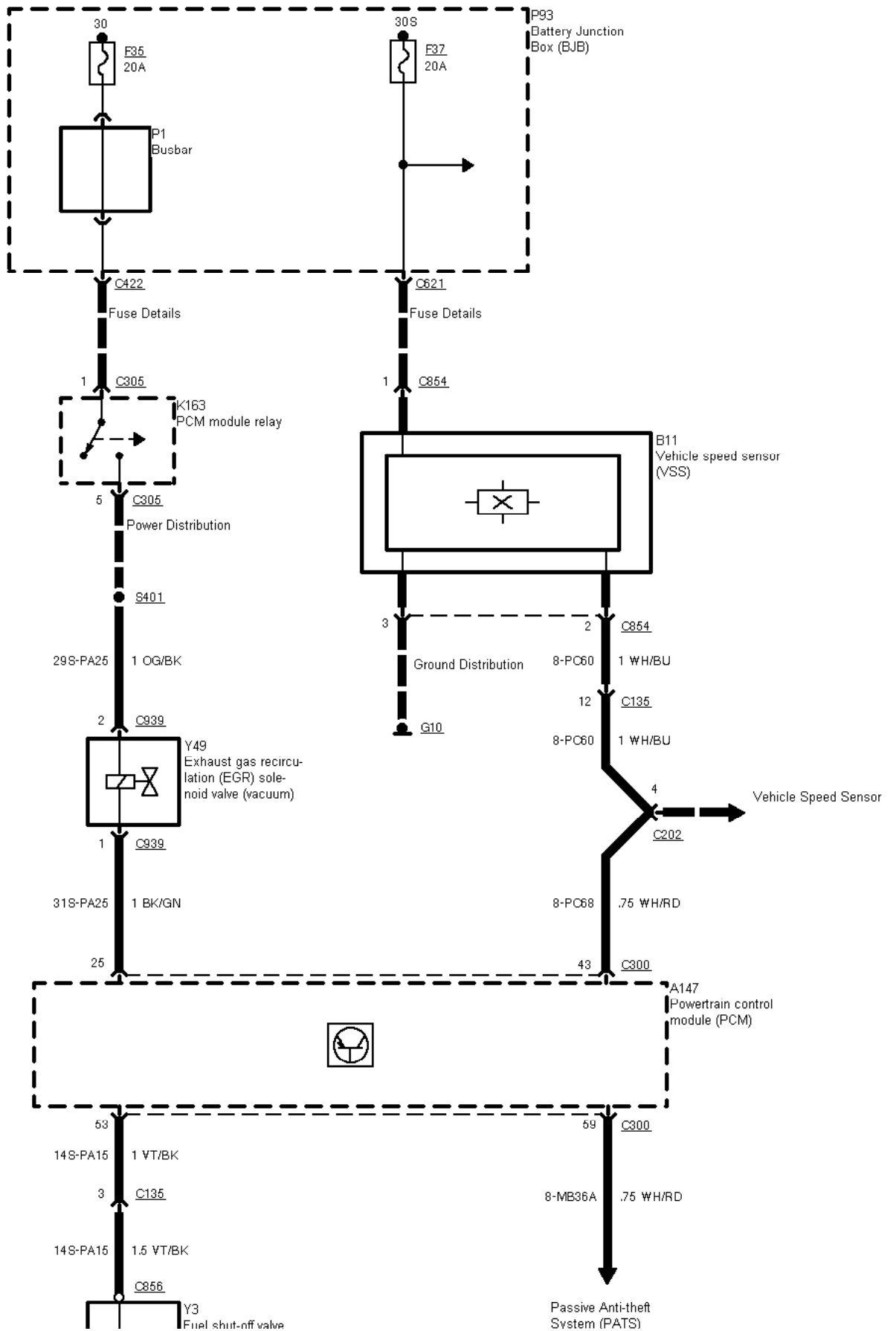

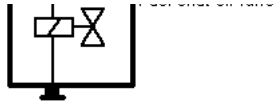

29-09-007 , Engine Control 2,5 I TCI Diesel (Automatic Transmission)

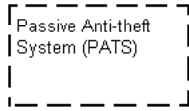

29-09-008 , Engine Control 2,5 I TCI Diesel (Automatic Transmission)

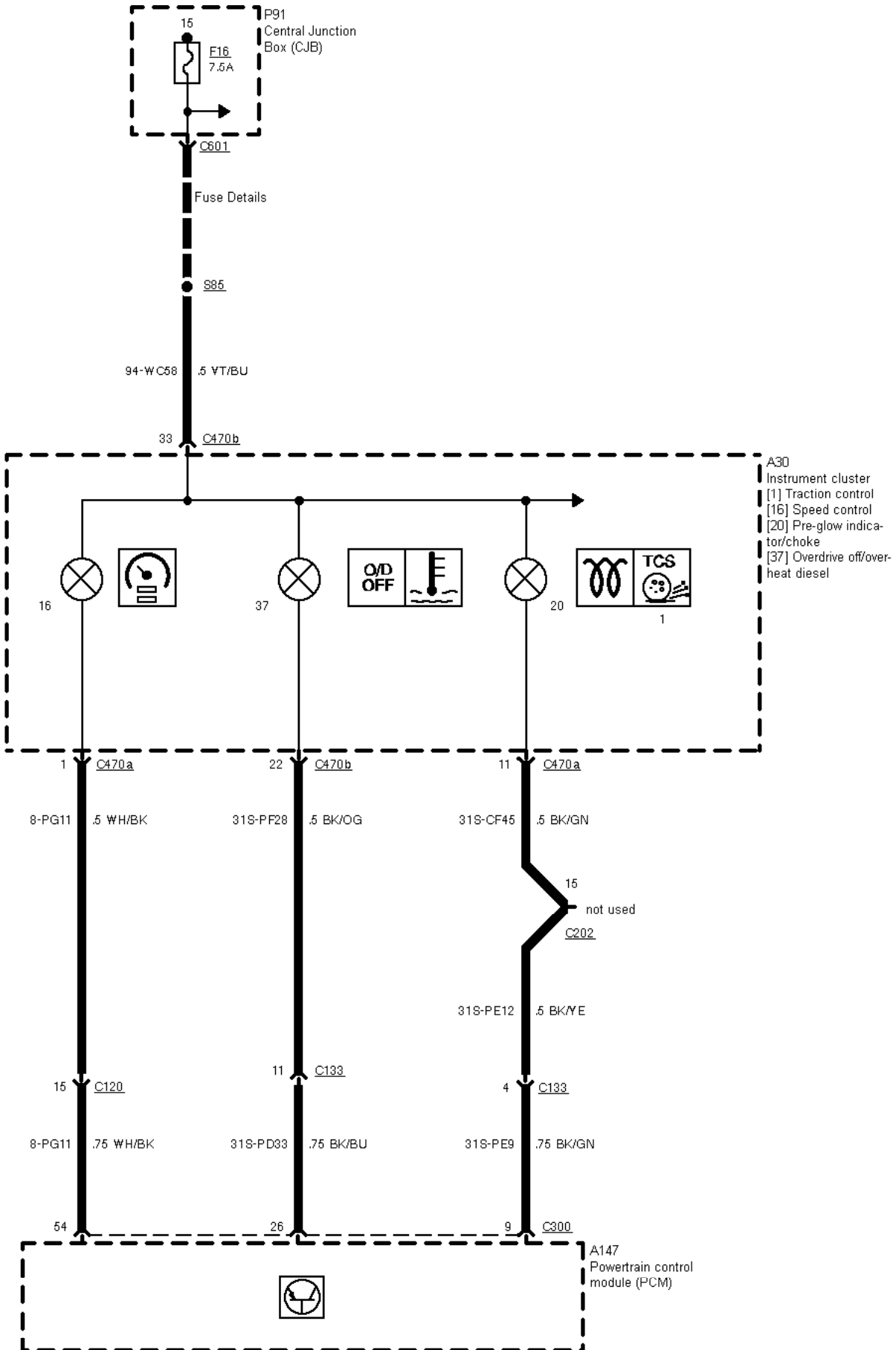

29-09-009 , Engine Control 2,5 l TCI Diesel (Automatic Transmission) , Pre-glow system

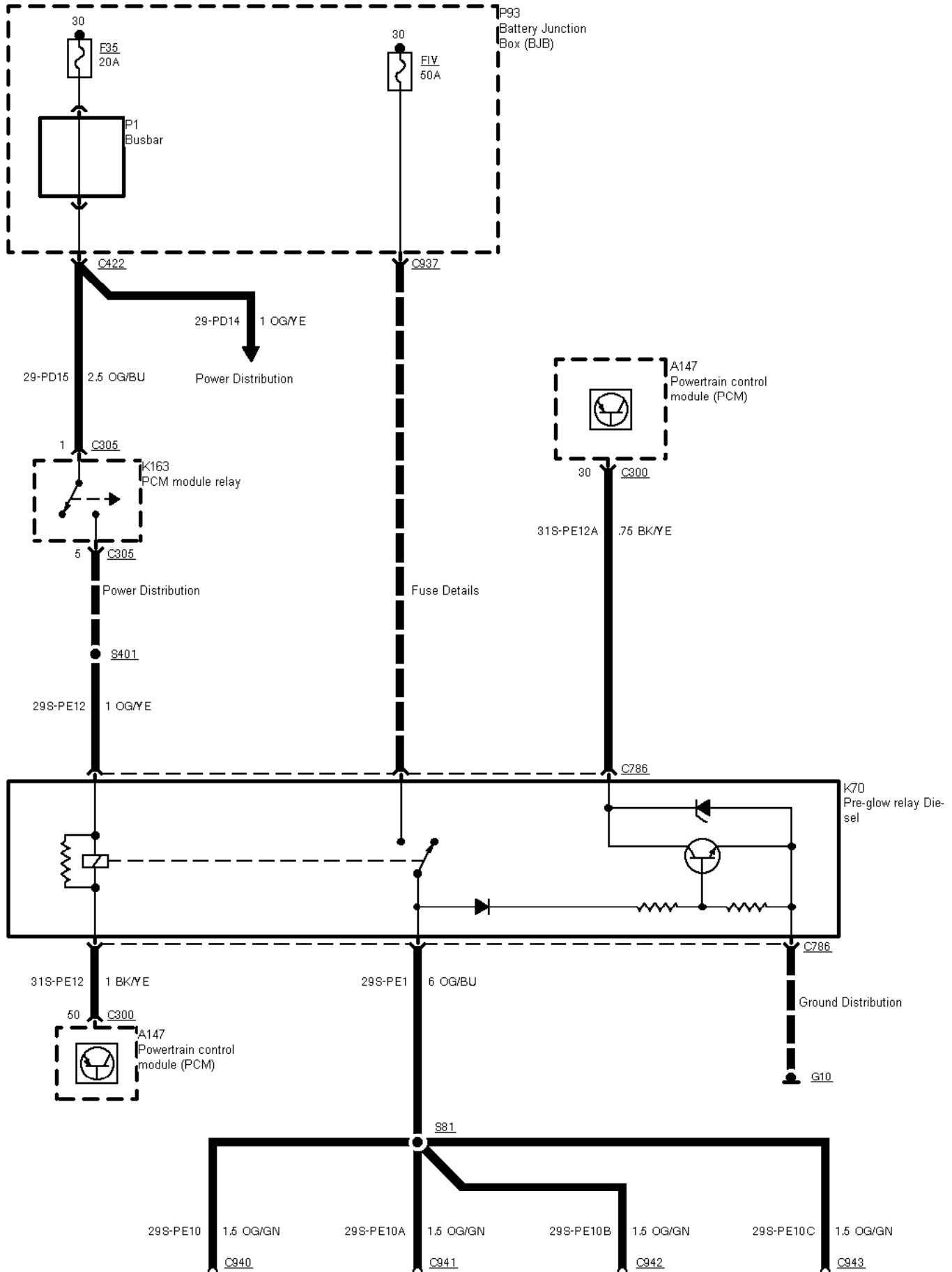

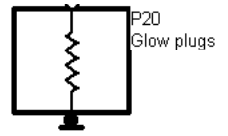
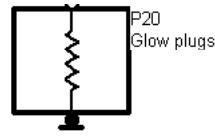
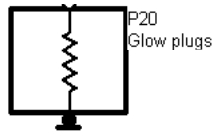
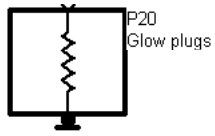

29-09-010 , Engine Control 2,5 I TCI Diesel (Automatic Transmission)

29-09-011 , Engine Control 2,5 I TCI Diesel (Automatic Transmission)

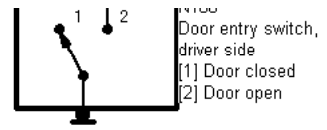

29-09-012 , Engine Control 2,5 I TCI Diesel (Automatic Transmission)

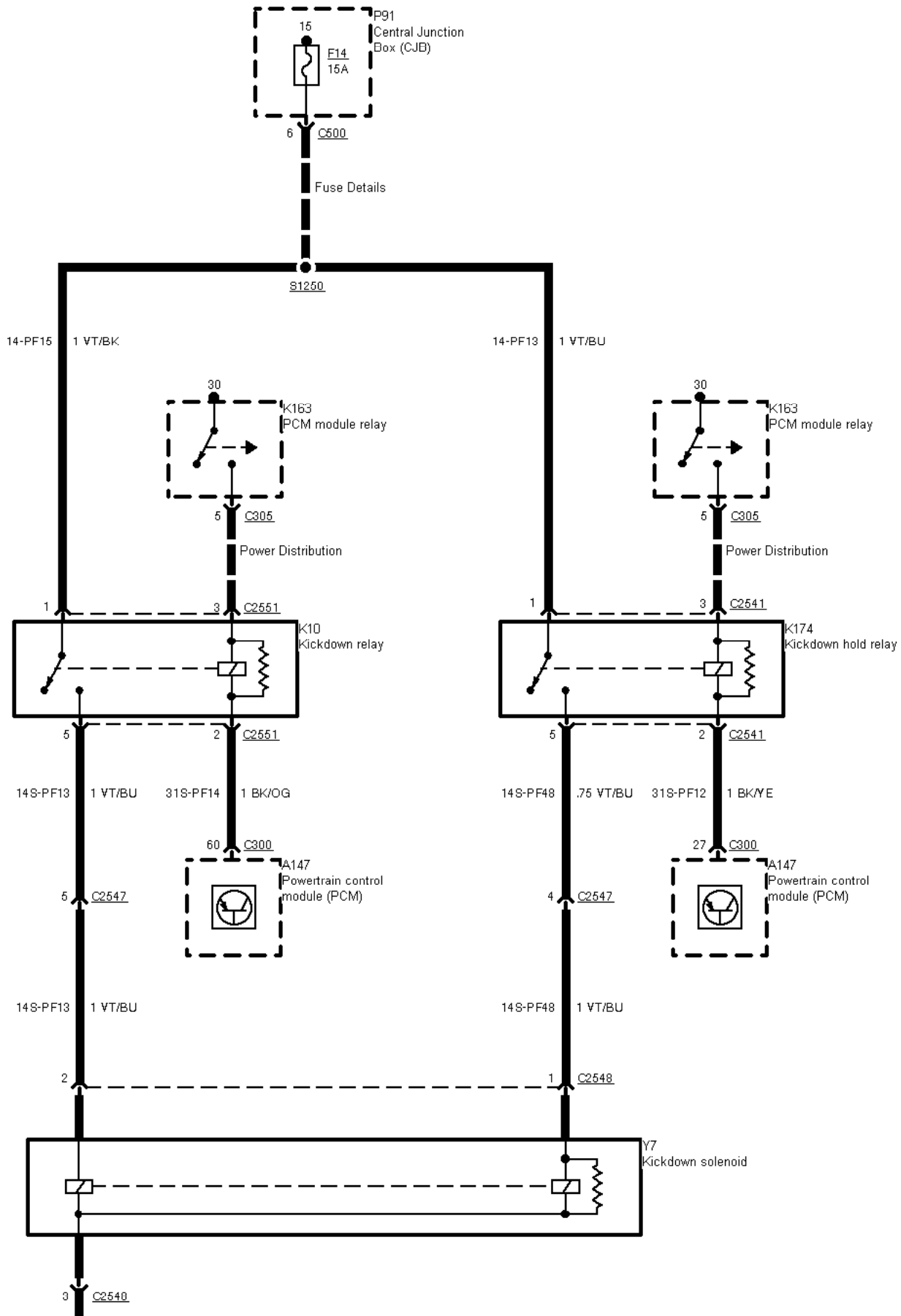

Ground Distribution



G10

29-09-013 , Engine Control 2,5 I TCI Diesel (Automatic Transmission)

29-09-014 , Engine Control 2,5 I TCI Diesel (Automatic Transmission)

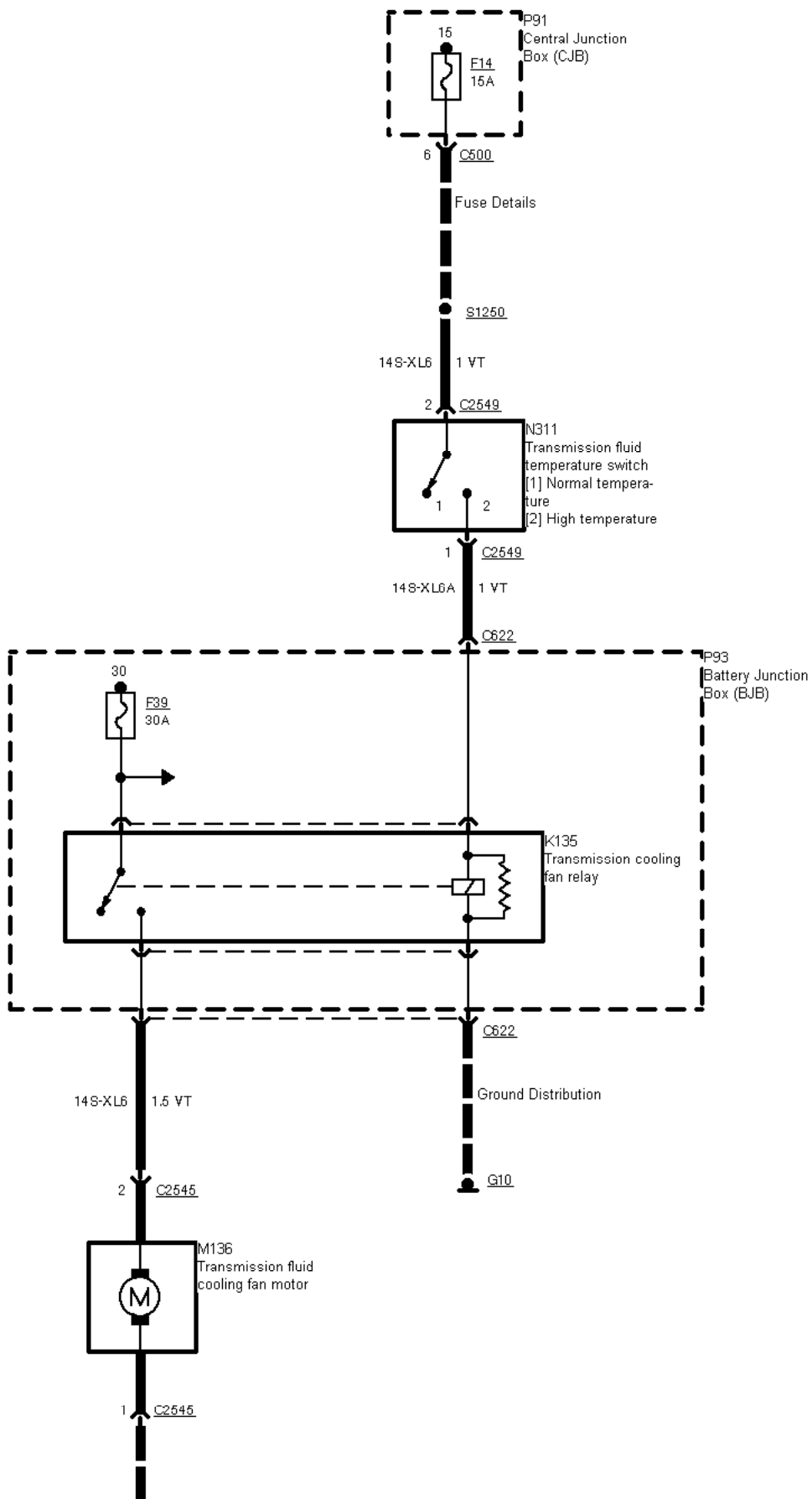

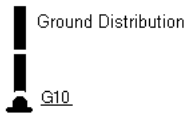

29-09-015 , Engine Control 2,5 I TCI Diesel (Automatic Transmission) , Engine cooling fan

